

5.961-229 01/04/2007478

 **KÄRCHER**

K 2.02

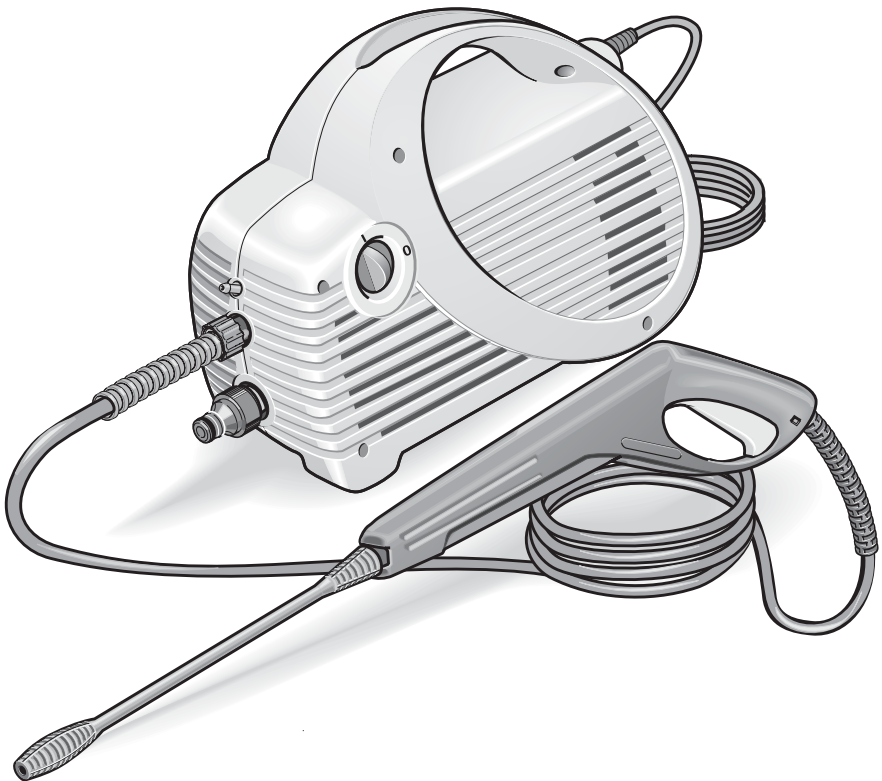

**PLEASE READ THIS LEAFLET CAREFULLY
BEFORE OPERATING YOUR MACHINE**

THANK YOU FOR PURCHASING A **KARCHER** PRESSURE WASHER

PLEASE READ THIS LEAFLET CAREFULLY BEFORE OPERATING YOUR MACHINE.

WHAT IS A PRESSURE WASHER?

A Pressure Washer is essentially a powerful electric motor driving a set of pistons that force water through a small nozzle, thus creating a pressurised jet of water. This provides the cleaning power behind the **Karcher** Pressure Washer.

A **Karcher** Pressure Washer can be used for an endless list of applications around the home and garden. It provides an efficient, economical and labour saving way of cleaning with excellent results.

All **Karcher** domestic pressure washers are designed to run from a suitable cold water supply although some models will accept a water inlet temperature of between 40 °C and 60 °C.

Environmental Comment - Save water with high pressure.

*The **Karcher** Pressure Washer is environmentally friendly enabling you to reduce your water consumption compared to a normal garden hose. A definite advantage with a metered water supply*

OR

with the added benefit of suction mode, water can be drawn from an open container such as a water butt.

INDEX

- 1. APPLICATIONS**
- 2. SAFETY INSTRUCTIONS**
- 3. GETTING STARTED**
 - 3.1 Contents**
 - 3.2 Water Connection**
 - 3.3 Electrical Connection**
 - 3.4 Suction Mode**
 - 3.5 Detergent**
- 4. OPERATING YOUR PRESSURE WASHER**
 - 4.1 High Pressure Operation**
 - 4.2 Low Pressure Operation Without Brush**
 - 4.3 Low Pressure Operation With Brush**
 - 4.4 End Of Operation**
- 5. IMPORTANT – CARE AND MAINTENANCE**
- 6. ACCESSORIES / SPARE PARTS**
- 7. PROBLEM CHECKLIST / TROUBLESHOOTING**
- 8. HELP-LINE**
- 9. TECHNICAL DATA**
- 10. ASSEMBLY**

1. APPLICATIONS

*The main applications for this product are **DOMESTIC** cleaning tasks:*

- **Cars, motorbikes, caravans, boats and bicycles**
- **Patio's, fences, garden walls, pathways, driveways and house facades – particularly useful for cleaning block driveways**
- **Removal of algae and moss from roofs, brickwork and guttering**
- **Garden tools and machinery, furniture and barbecues**
- **Hygienic cleaning of animal pens and their surroundings**

*With the addition of **Karcher** accessories, the list continues*

- **Clearing blocked drains and pipes**
- **Removal of old paint and rust from garden furniture and gates**
- **Spraying insecticide onto trees, plants and lawns**

2. SAFETY INSTRUCTIONS

BEFORE STARTING UP YOUR PRESSURE WASHER PLEASE CHECK YOU HAVE THE FOLLOWING:

We recommend you purchase these items from a reputable store

- **RCD plug and socket that will interrupt electrical supply in an emergency**
 - **A typical garden hose (minimum length 7.5 metres) with suitable hose connection (Hoselock/Gardena type) to match the coupling on the machine (hose and connector not supplied).**
-
- The mains voltage and supply indicated on the Rating Plate of the machine corresponds with that of the power source
 - The insulation of the supply cable is not damaged
 - Only earthed sockets should be used
 - If you are using an extension cable it must be completely unwound from the cable drum and be the correct diameter:

**10 metre length of cable should have a cross section of 1.5 mm²
30 metre length of cable should have a cross section of 2.5 mm²**

Safety Assurance

As an added precaution, your pressure washer is fitted with a safety locking device on the Spray Gun.

AFTER USE, ALWAYS REMOVE THE PLUG FROM THE SOCKET BEFORE CLEANING YOUR PRESSURE WASHER.

2. SAFETY INSTRUCTIONS

- ⚠ Never use defect connection or extension lines! If the connection line is damaged, it must be replaced with a special connection line that is available from the manufacturer or his customer service.
- ⚠ Please make sure that the connection or extension lines are not damaged by being ran over, pulled or dragged. Protect the connection lines from heat, oil, and sharp edges.
- ⚠ Never touch the mains plug and the socket with wet hands.
- ⚠ The connection between connection line and extension line must not lie in the water.
- ⚠ All current-carrying components within the working area must be jet-proof.
- ⚠ The appliance may only be connected to an electrical connection that was performed by an electrician according to IEC 60364.
- ⚠ Only connect the appliance to alternating current. The voltage must comply with the voltage specified on the typeplate.
- ⚠ To avoid electric accidents, we recommend to use sockets with a series connected residual current operated device (rated breaking current max. 30 mA).
- ⚠ **Warning:** Inappropriate extension lines may be dangerous. If you work outside, only use extension lines that are approved and specifically labelled and provide of a sufficient conductor cross section (see page 5).
- ⚠ The plug and the coupling of an extension line must be waterproof.
- ⚠ Always unwind the extension line completely from the cable drum.
- ⚠ The operation of the device in hazardous locations is not admissible.
- ⚠ Please comply with the corresponding safety instructions if you use the appliance in danger areas (e.g. filling stations).
- ⚠ Do not turn on the appliance if the power supply line or important components of the appliance, such as safety components, high-pressure hoses, spray jet, are damaged.
- ⚠ **Warning:** High-pressure hoses, fittings, and couplings are of importance for the appliance safety. Only use high-pressure hoses, fittings, and couplings recommended by the manufacturer.

- ⚠ The appliance is not intended for use by young children or infirm persons without supervision. Young children should be supervised to ensure that they do not play with the appliance.
- ⚠ The operator must use the appliance properly. He must take the local conditions into consideration and must pay attention to third persons, in particular children, while working with the appliance.
- ⚠ **Warning:** Do not use the appliance if third persons are within the reach of the appliance unless such persons wear protective clothes.
- ⚠ **Warning:** High-pressure jets may be dangerous if they are used improperly. The jet must not be directed at people, animals, active electrical equipment, or the appliance itself.
- ⚠ Never direct the jet at yourself or third persons to clean clothes or shoes.
- ⚠ Never use the appliance to spray objects containing hazardous substances (e.g. asbestos).
- ⚠ **Warning:** Vehicle tyres/tyre valves may be damaged and burst by the high-pressure jet. A first sign is the discoloration of the tyre. Damaged vehicle tyres/tyre valves are hazardous. Always perform the cleaning with a minimum distance of 30 cm.
- ⚠ Cleaning operations during which oil saturated waste water is generated, such as engine cleaning and underbody cleaning, may only be performed in cleaning locations that are equipped with an oil separator.
- ⚠ If you clean varnished surfaces, please respect a minimum distance of 30 cm to avoid damages.
- ⚠ Never take in solvent-containing liquids or undiluted acids and solvents! These include, for example, benzene, paint thinner, or heating oil. The spray is highly inflammable, explosive, and toxic. Do not use acetone, undiluted acids, and solvents as they affect the materials used on the appliance.
- ⚠ If required, wear appropriate protective clothes and glasses to protect yourself from return spray.
- ⚠ Never leave the appliance unattended as long as it turned on.

3. GETTING STARTED

3.1 Contents

Upon opening the carton, if you do not have all the items as detailed please contact the Customer Helpline.

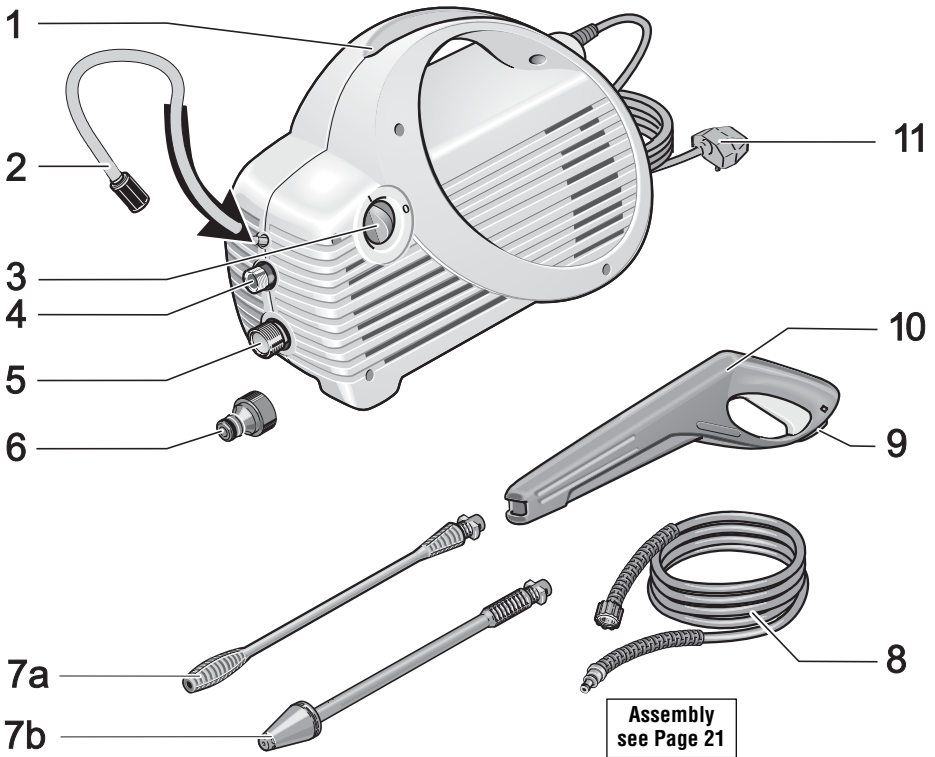

- 1 Carry Handle
- 2 Detergent Suction Tube
- 3 On/Off Switch
- 4 High Pressure Outlet
- 5 Inlet Water Connection (with Strainer)
- 6 Hosepipe Connector

- 7a High Pressure Lance
- 7b Dirtblaster Lance
- 8 High Pressure Hose
- 9 Safety Lock Device
- 10 Spray Gun with Built-in Low Pressure Jet
- 11 Mains Electric Lead with Plug

Please follow these instructions carefully for troublefree cleaning

Use the diagram on Page 8 for reference purposes

3.2 Water Connection

- The minimum length of supply hosepipe advised for maximum user convenience is 7.5 metres with a diameter of 12.5 mm (1/2") to avoid backpressure and any associated potential damage to your machine.
- Attach your supply hosepipe with its connector to the coupling on the machine (No. 6) and the other end should be connected to a suitable water supply

3.3 Electrical Connection

- Ensure the Power Switch (No.3) is in the "OFF" position before connecting the factory fitted Plug attached to the Mains Electric Lead (No.11) into an earthed socket.

If using an Extension Cable make sure it is completely unwound from the cable drum and is the correct diameter.

3.4 Detergent

Only cleaning agents recommended by Karcher (UK) Ltd. should be used. Unsuitable detergents could damage your Pressure Washer and the object being cleaned.

Recommended Detergents

- 1. The following cleaning agent may be used undiluted:**
(But further dilution is practical but trial before application)
Universal Cleaner Profi RM 555 ASF
- 2. The following cleaning agents are available as concentrate and must be diluted with 9 parts of water (1 : 9) before use:**
Universal Cleaner Profi RM 555 ULTRA
Automotive Cleaner Profi RM 565 ULTRA
House & Garden Cleaner Profi RM 570 ULTRA
Boat Cleaner Profi RM 575 ULTRA
- 3. Detergent tablets are also available from some stores**
Karcher Clean Tabs (10 tablets per box)
10 Tablets dissolved in clean water provide 5 litres of cleaning detergent.

4. OPERATING YOUR PRESSURE WASHER

If you have followed all the instructions so far, you are now ready to have fun cleaning the KARCHER way!!!

- Turn on the supply water and press the Spray Gun lever (No.10) until the water flows freely and removes all air locks from the hoses
- You may now attach the High Pressure Lance (No.7a) or required accessory to the Spray Gun.

All accessories are bayonet fit, simply push in and twist until they click into position !

- Once water is flowing through the machine, you may now switch on your Karcher Pressure Washer using the Power Switch (No.3)

WHEN USING YOUR KARCHER PRESSURE WASHER ON THE HIGH PRESSURE SETTING, THE RECOMMENDED WORKING DISTANCE BETWEEN THE NOZZLE AND THE OBJECT OR SURFACE TO BE CLEANED IS 30 CM.

IT CAN BE CLOSER IF REQUIRED FOR PATIOS OR MASONERY

It is your responsibility to check the suitability of the surface to be cleaned. **Karcher (UK) Ltd.** cannot be held responsible for any damaged caused.

4.1 High Pressure

- Ensure the High Pressure Lance (No.7a) is attached securely to the Spray Gun (No.10).
- Aim the lance towards the object to be cleaned making sure the recommended working distance is used for reference (See Page 11). Release the Safety Lock Device (No.9) and squeeze the lever.
- Switch on the pressure washer (No.3)

Dirtblaster Lance (No.7b)

A rapidly rotating pencil jet achieves a very high impact pressure so that it has a very good cleaning effect. Use it to remove loose paint, stubborn algae and moss from hard surfaces.

The pressurised water jet alone is capable of fulfilling most cleaning tasks around the garden or on building work but detergent and wash brush are advantageous when cleaning vehicles or other paint finishes.

4.2 Low Pressure Operation

- Dilute the detergent in a suitable container to the required concentration before using. (The correct dilution is dependent on the degree of soiling of surface and is best determined by experience).
- Hang the Detergent Suction Tube (No.2) in the Detergent container.
- Use the Spray Gun (No.10) without Spray Lance.
- Aim the Spray Gun towards the object to be cleaned, release the Safety Lock Device (No.9) on the Spray Gun and squeeze the lever to apply the detergent to the working area.
- Switch on the pressure washer (No.3)
- To rinse the detergent away, close the Spray Gun, attach the High Pressure Lance (No.7a). **No detergent can be drawn in with a high working pressure.** Spray with the high pressure jet until no trace of detergent can be found.

4.3 Low Pressure Operation with Brush (not included)

When cleaning surfaces with a grease contamination - typically car paintwork that always has a greasy traffic film covering. Follow the procedure of:

- Washing loose dirt away with the clean water high pressure spray.
- Apply the detergent in low pressure mode by removing the bayonet fit spray lance and fitting the Washing Brush (Part No. 6.903-275) to the Spray Gun.
- Leave for 2-4 minutes for the detergent to have maximum effect.
- With or without the pressure washer switched on, brush down the surface being cleaned, this physical agitation removes all trace of traffic film.
- Finally revert to the high pressure operation with the Spray Lance and complete the wash down.

We recommend the following cleaning method:

Step 1:

Remove loose dirt by washing over the surface to be cleaned with the high pressure jet.

Step 2:

Spray on the detergent and leave for 1-4 minutes, so assisting the easy removal of fine dirt and associated greasy adhesions.

Step 3:

Finally, spray off the loosened dirt with the high pressure spray.

4.4 End Of Operation

ALWAYS REMEMBER TO RINSE YOUR PRESSURE WASHER AFTER USING DETERGENT BY HANGING THE DETERGENT SUCTION TUBE IN A CONTAINER WITH CLEAN WATER AND RUN THE PUMP FOR APPROXIMATELY ONE MINUTE IN LOW PRESSURE SETTING.

In the event of a break of 5 minutes in the operation of your Karcher Pressure Washer, always switch off the pump to avoid damage due to overheating.

- Switch off the pressure washer by the Power Switch (No.3) and unplug the Mains Electric Lead (No.11) from the socket .
- Close the water inlet (tap) and disconnect the hosepipe.
- **Squeeze the lever to remove all pressure from the machine. Release the lever and then secure the lever with the Safety Locking Device to prevent accidental opening.**

5. IMPORTANT – CARE AND MAINTENANCE

To ensure prolonged life and trouble-free use of your Karcher Pressure Washer we strongly recommend that you always adopt the following procedures:

Water

- Before use, always check the inlet filter for dirt or debris.
- Visually check to see if the nozzle is blocked by dirt or grit, if so, remove the dirt from the nozzle hole with a needle and rinse with water from the front.

Failure to do this will seriously damage your machine and invalidate the warranty.

- Connect the water supply hose and, without the lance attached, squeeze the Spray Gun lever to run water through your pressure washer until the water flow is constant. Then plug in to the electric supply.
- Unless drawing water from an open water source such as a water butt, always have a minimum of 10 metres (25 feet) of uncoiled hose between the water tap and your machine. The internal diameter of the feed water hose should be 12 mm (1/2”).
- Water Regulations require the use of a back-flow preventer valve at the tap end of the supply hose.
Only use a full flow connector to connect the hose to the machine.

Electricity

- If using an electrical extension lead it must be rated at a minimum of 13 amps.
- Always fully uncoil any extension lead when used.

Chemicals

Use of chemicals other than those recommended by Karcher could cause significant damage which may not be covered by your warranty.

- After using chemicals, always run fresh water through your machine.
- The high pressure hose of your Karcher Pressure Washer should not be mistreated. It is designed to withstand high pressure operation so vehicles should NOT run over it, nor should it be pulled across sharp or abrasive edges. These actions may weaken the hose and cause ballooning.

IMPORTANT

REMEMBER FROST WILL DAMAGE YOUR KARCHER PRESSURE WASHER IF IT HAS NOT BEEN COMPLETELY EMPTIED OF WATER AFTER USE.
ALWAYS STORE IN A FROST FREE AREA.

6. ACCESSORIES

A wide range of popular accessories are available from your local store selling Karcher Pressure Washers.

4.763-228 Dirt Blaster/Rotary Jet

A rapidly rotating pencil jet used to remove loose paint, stubborn algae and moss from hard surfaces.

4.760-269 Triple Nozzle Lance

An integral fan jet, pencil jet and low pressure chemical jet in one unit allows optimal nozzle selection.

4.760-212 Underbody Lance

Extended lance with angled end and upward firing jet for cleaning under cars, gutters etc.

6.903-276 Car Wash Brush

Simple bayonet fitting attaches the brush to the hand gun, used in conjunction with RM555.

4.762-065 Rotary Wash Brush

Ideal for car bodywork and windows as the water forces the brush to rotate enhancing cleaning power.

4.760-262 Extension Lance

To add length to the standard lance.

2.637-729 Drain Kit (7.5 m Hose)

2.637-767 Drain Kit (15 m Hose)

A flexible hose with backwards firing high pressure jet to create turbulence and dislodge blockages.

2.637-728 Sandblaster

Used to remove paint, rust and cement from metallic and stone surfaces by using a combination of high pressure water and sand.

4.760-265 Flexi Lance

A lance which can be angled to any degree to clean hard to reach areas such as wheel arches etc.

2.637-755 Floor Cleaning Lance

An extended lance fitted with three shrouded high pressure nozzles to provide a wide area of cleaning power without any splash back.

4.440-238 Suction Hose and Filter

Used to provide a water supply to the unit where a mains water supply is not available by placing the kit into a water butt.

6.541-040 Trolley

Eliminates the need to carry the pressure washer when the unit has no built in mobility.

6.964-006 Foam Nozzle

A bayonet fit accessory that generates a low pressure detergent foam. This allows longer detergent contact time on the surface to be cleaned.

2.637-214 Water Pump Kit

9.300-051 25 Kg Grit

6.291-080 RM 555 (5 litre)

6.291-079 RM 555 (6 x 1 litre)

6. SPARE PARTS

In the event that your Karcher Pressure Washer requires replacement parts – please refer to the diagram below AND identify the particular model of your machine by reference to the data plate on the underside.

Please write, email or fax Karcher (see page 19) with any parts order you wish to place. A premium rate **Help-line** Number is available for telephone enquires of any type.

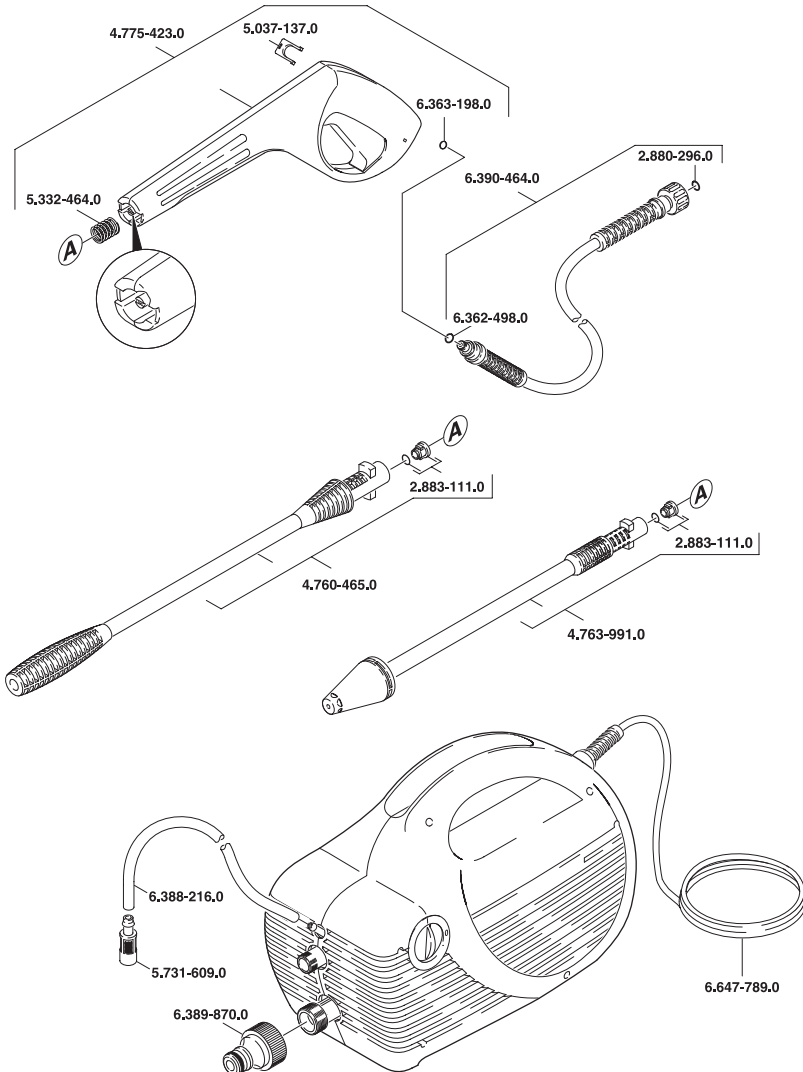

7. PROBLEM CHECKLIST

The machine you have chosen is of the highest quality. Correctly stored away from frost it should operate without problems. If a problem does arise, please check the following chart as a solution may be at hand.

PROBLEM	POSSIBLE CAUSE	CORRECTION
Machine refuses to start	Plug not connected	Connect plug
	Defective socket	Try another socket
	Fuse blown	Change the fuse
	Defective extension cable	Try without extension cable
	Wrong mains voltage	Check mains voltage corresponds to specifications of machin
Pump stops	Fuse blown	Change fuse and check size of extension cable
	Overheating due to poor water Supply	Check inlet water flow rate - hose should fill a 10 litre bucket in one minute
Strong pressure fluctuations	Nozzle partly blocked	Clean dirt from nozzle hole with needle and rinse from the front
Machine does not reach operating pressure	Nozzle blocked/worn out	Clean/replace nozzle
	Inadequate mains water	Check inlet water flow rate
	Inlet hose squeezed	Straighten out hose
	Water filter clogged (3.1 item 5)	Clean filter
	Inlet hose blocked	Check hose for leaks or blockages
No detergent suction	Wrong pressure	Use SprayGun without Spray Lance
	Blocked Detergent Filter	Unblock Filter

In the unlikely event that you need to return your machine to your supplier, **please ensure that this is returned, complete with hose, gun and all accessories.**

8. HELP - LINE

Karcher (UK) Limited operate a help-line allowing customers to discuss any problems experienced with our products.

The help-line operates during normal business hours, if you have difficulty getting through, please understand that there are peak periods during the day when our consultants are unable to take all calls coming in. In these circumstances we would ask that you try to contact us again later in the day.

The help-line number is 0906 6800632

(calls at this number are charged at 25p per minute)

From 8.30am to 5.00pm Monday – Friday

It helps us if you have the model number and data plate details to hand before making your call as there are very many different models of Karcher Pressure Washers in use.

Alternatively you may write or e-mail to the address below:

Karcher (UK) Limited

Karcher House

Beaumont Road

Banbury

Oxon, OX16 1TB

FAX: 01295 752030

E-mail: retail_inquiries@karcheruk.co.uk

9. TECHNICAL DATA

Power Connection

Voltage	220-240 V-AC
Current	1~50/60 Hz
Connected/Load	1.4 KW
Mains Fuse	13 AMP

Water Connection

Supply Temperature (Max)	40 °C
Supply Rate (Min)	8 litres per minute
Supply Pressure (Max)	(12 bar) 1,2 MPa
Supply Hose Length	7.5 metres
Diameter	1/2 inch

Performance Data

Pump Pressure (Max at bypass)	(100 bar) 10 MPa
Operating Pressure	(80 bar) 8 MPa
Flow Rate	(330 l/h) 5,5 litres per minute
Detergent Intake	0,3 litres per minute
Recoil Force of Spray Gun at Max. Pressure	10 N
Optimum Working Distance on High Pressure	30 cm
Hand-transmitted vibration (ISO 5349)	0,8 m/s ²
Sound pressure level L _{PA} (EN 60704-1)	77 dB(A)
Sound power level L _{WA} (2000/14/EC)	92 dB(A)

Dimensions

Length	365 mm
Width	145 mm
Height	250 mm
Weight	5 Kg

Circuit Diagram

- M1 Motor
- Q1 Appliance switch
- S1 Pressure-operated switch
- Z 1 Suppressor

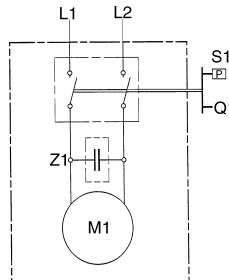

10. ASSEMBLY

High Pressure Hose (No.8) and Spray Gun (No.10) Assembly

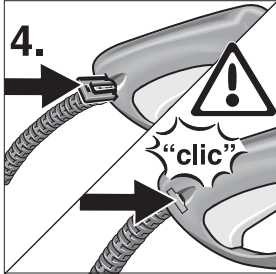
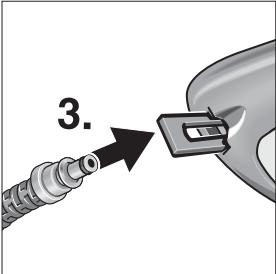
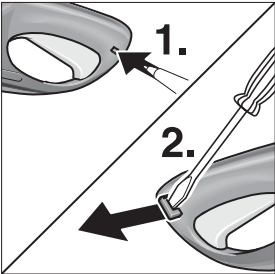
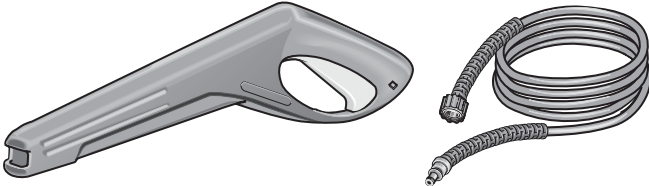

EU Declaration of Conformity

We hereby declare that the equipment described below conforms to the relevant fundamental safety and health requirements of the appropriate EU Directives, both in its basic design and construction as well as in the version marketed by us. This declaration will cease to be valid if any modifications are made to the machine without our express approval.

Product: High-pressure cleaner

Model: 1.320-xxx

Relevant EU Directives:

EU Machinery Directive 89/392/EEC (+ 91/368/EEC, 93/44/EEC, 93/68/EEC, 98/37/EC)

EU Low-Voltage Equipment Directive 73/23/EEC (+ 93/68/EEC)

EU Directive on Electromagnetic Compatibility 89/336/EEC

(+ 91/263/EEC, 92/31/EEC, 93/68/EEC)

EU Directive on Noise 2000/14/EC

Harmonised standards applied:

DIN EN 55014-1:2000 + A1:2001

DIN EN 55014-2:1997

DIN EN 60335-1

DIN EN 60335-2-79

DIN EN 61000-3-2:2000

DIN EN 61000-3-3:1995 + A1:2001

Conformity assessment procedure followed:

Annex V

Sound power level

Measured: 90 dB(A)

Guaranteed: 92 dB(A)

Appropriate internal measures have been taken to ensure that series-production units conform at all times to the requirements of current EU Directives and relevant standards. The signatories are empowered to represent and act on behalf of the company management.

Alfred Kärcher GmbH & Co. KG
Cleaning Systems
Alfred-Kärcher-Str. 28-40
P.O. Box 160
D-71349 Winnenden
Tel.: ++ 49 71 95 14 0
Fax: ++ 49 71 95 22 12

H. Jenner

S. Reiser

5.957-684 09/03

Notes



www.karcher.com