

# K 3.91 M

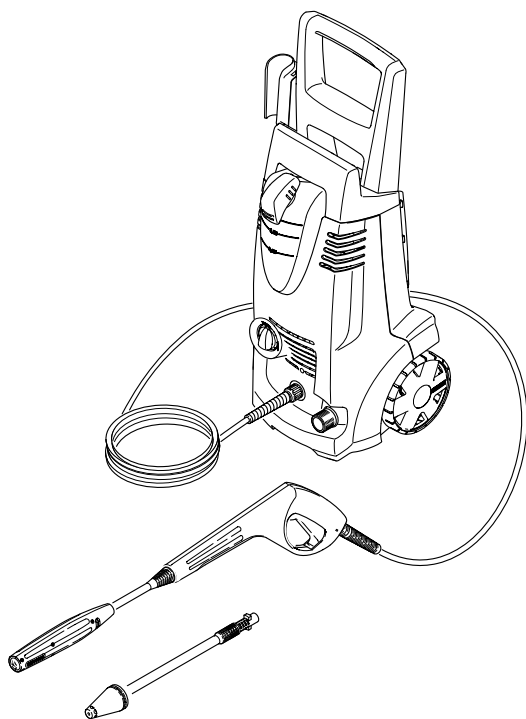

Deutsch	3
English	9
Français	15
Italiano	22
Nederlands	28
Español	34
Português	41
Dansk	48
Norsk	54
Svenska	60
Suomi	66
Ελληνικά	72
Türkçe	79
Русский	85
Magyar	93
Česky	99
Slovenščina	105
Polski	111
Românește	118
Slovenčina	124
Hrvatski	131
Srpski	137
Български	143
Eesti	151
Latviešu	157
Lietuviškai	163

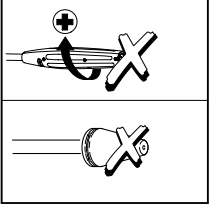

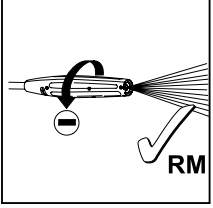
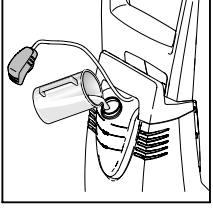
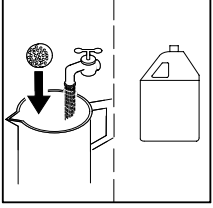
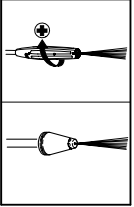
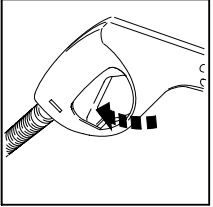
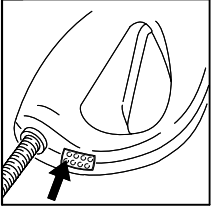
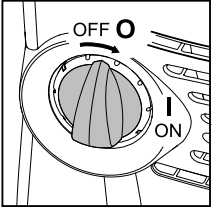
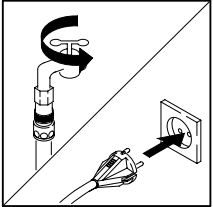
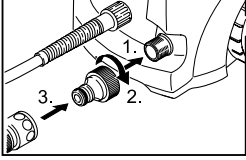
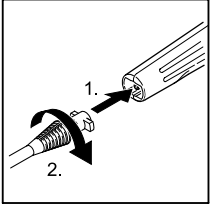
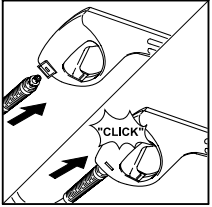
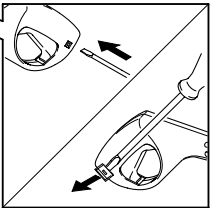
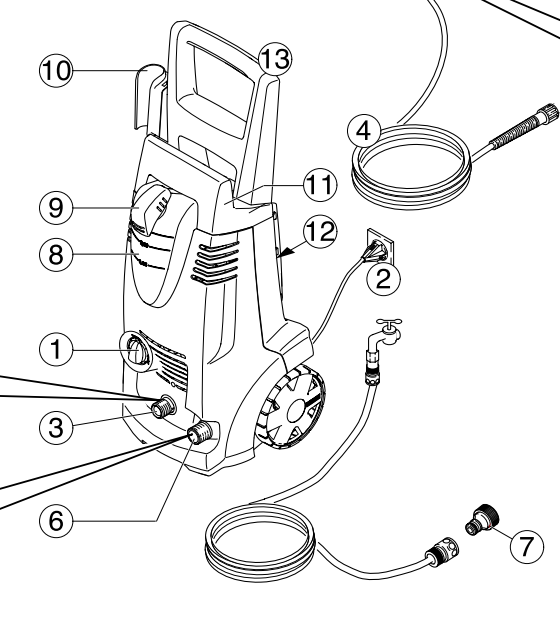
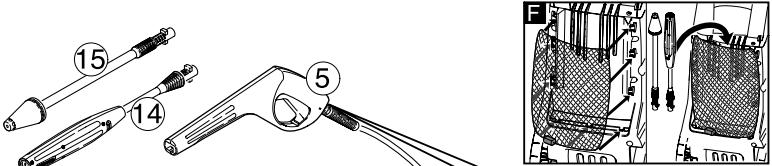
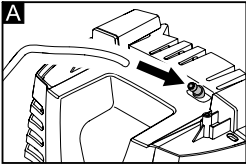
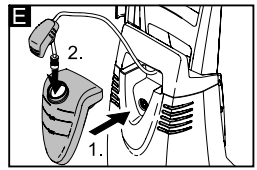
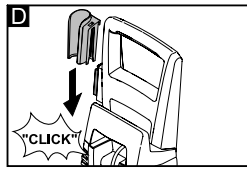
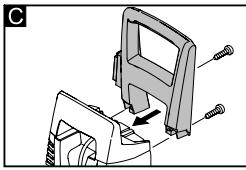
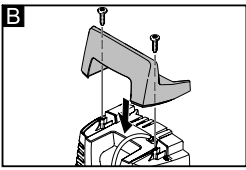

## Dear Customer,



Please read and comply with these instructions prior to the initial operation of your appliance. Retain these operating instructions for future reference or for subsequent possessors.

### Proper Use

This high-pressure cleaner is designed for domestic use only:

- to clean machines, vehicles, buildings, tools, facades, terraces, garden equipment etc. using a high-pressure water jet (and detergents if required).
- with accessories, replacement parts and detergents approved by Kärcher. Observe the instructions provided with these detergents.

### Environmental protection



The packaging material can be recycled. Please do not place the packaging into the ordinary refuse for disposal, but arrange for the proper recycling.



Old appliances contain valuable materials that can be recycled. Please arrange for the proper recycling of old appliances. Batteries, oil, and similar substances must not enter the environment. Please dispose of your old appliances using appropriate collection systems.

### Warranty

The terms of the guarantee applicable in each country have been published by our respective national distributors. We will repair possible faults on your unit free of charge within the warranty period, insofar as the faults are caused by material defects or defective workmanship. Guarantee claims should be addressed to your dealer or the nearest authorized customer service centre, and supported by documentary evidence of purchase.

## Safety Instructions

### ⚠ Danger

- *Never touch the mains plug and the socket with wet hands.*
- *The appliance must not be used if the power cable or important parts of the appliance, e.g. safety devices, high-pressure hoses, spray guns, are damaged.*
- *The appliance may not be used in areas where a risk of explosion is present.*
- *If the appliance is used in hazardous areas (e.g. filling stations) the corresponding safety provisions must be observed.*
- *Check the power cord with mains plug for damage before every use. If the power cord is damaged, please arrange immediately for the exchange by an authorized customer service or a skilled electrician.*
- *High-pressure jets can be dangerous if improperly used. The jet must not be directed at persons, animals, live electrical equipment or at the appliance itself.*
- *The jet must not be directed at other persons or directed by the user at him/herself to clean clothing or footwear.*
- *Never use the appliance to clean objects containing hazardous substances (e.g. asbestos).*
- *Vehicle tyres or tyre valves are susceptible to damage from the high-pressure jet and may burst. The first indication of this is a discolouration of the tyre. Damaged vehicle tyres/tyre valves are highly dangerous. Ensure that a distance of at least 30 cm is observed when cleaning with the jet!*
- *Never draw in fluids containing solvents or undiluted acids and solvents! This includes petrol, paint thinner and heating oil. The spray mist thus generated is highly inflammable, explosive and poisonous. Do not use acetone, undiluted*



acids and solvents as they are aggressive towards the materials from which the appliance is made.

### **⚠ Warning**

- Unsuitable extension cables can be hazardous. Only use extension cables outdoors which have been approved for this purpose and labelled with a sufficient cable cross section:

1 - 10 m: 1.5 mm<sup>2</sup>

10 - 30 m: 2.5 mm<sup>2</sup>

- Check the high-pressure hose for damage before every use. Please arrange for the immediate exchange of a damaged high-pressure hose.
- High-pressure hoses, fixtures and couplings are important for the safety of the appliance. Only use high-pressure hoses, fixtures and couplings recommended by the manufacturer.
- Cleaning operations which produce oily waste water, e.g. engine washes, underbody washes, may only be carried out using washing stations equipped with an oil separator.

### **Note**

- The appliance must not be operated by children or persons who have not been instructed accordingly.
- The operator must use the appliance properly. When working with the appliance, he must consider the local conditions and pay due care and attention to other persons, in particular children, who are nearby.
- Observe a distance of at least 30 cm when using the jet to clean painted surfaces to avoid damaging paintwork.
- Wear protective clothing and safety goggles to protect against back spray containing water or dirt.
- Never leave the appliance unattended when it is in operation.
- This appliance was designed to be used with detergents which are supplied or recommended by the manufacturer. The

use of other detergents or chemicals may compromise the safety of the appliance.

- Make sure that the power cable or extension cables are not damaged by running over, pinching, dragging or similar. Protect the power cable from heat, oil, and sharp edges.
- The connection between the power cable and extension cable must not lie in water.
- All current-conducting parts in the working area must be protected against jet water.
- The appliance may only be connected to an electrical supply which has been installed in accordance with IEC 60364.
- The appliance may only be connected to alternating current. The voltage must correspond with the type plate on the appliance.
- The minimum fuse rating required at the socket outlet is 10 A (slow-blow).
- To avoid accidents due to electrical faults we recommend the use of sockets with a line-side current-limiting circuit breaker (max. 30 mA nominal tripping current).
- The plug and coupling of the extension cable used must be watertight.
- Always fully unroll electrical cables from the cable drum.

## **Safety Devices**

Safety devices prevent injury and may not be modified or bypassed.

### **Unit switch**

The switch prevents unintended starting of the appliance. Stop the appliance during breaks or after operation.

### **Safety catch**

The safety catch on the handgun prevents the appliance from being switched on unintentionally.

# Commissioning and operation

## Definition of abbreviations used:

HP	=	High pressure
DT	=	Detergent

## Description of the Appliance

When unpacking the product, make sure that no accessories are missing and that none of the package contents have been damaged. If you detect any transport damages please contact your dealer.

### Illustrations on Page 2

- 1 ON/OFF switch for appliance
- 2 Power cable with plug
- 3 HP outlet
- 4 HP hose
- 5 Handgun with safety catch
- 6 Connection for water supply with filter
- 7 Coupling element for water connection
- 8 DT tank
- 9 DT suction hose with filter
- 10 Accessory mount, Handgun
- 11 Accessory mount, HP hose
- 12 Accessory mount, Spray lance
- 13 Transport handle
- 14 Spray lance with Variopower nozzle
- 15 Spray lance with dirt blaster

## Initial start-up

When the appliance is delivered, the HP hose and handgun are not attached, this prevents buckling. Please mount these before using the appliance for the first time.

- Push out the safety clip in the handgun using e.g. a small screwdriver.
- Join HP hose and handgun together.
- Push clip in until it engages and check that it is securely fastened by pulling on the HP hose.
- Remove cable tie and unroll HP hose

## Water supply

### Water supply from mains

For connection values, see type plate/technical data.

Observe regulations of water supplier.

- Use a fibre-reinforced hose (not includ-

ed) with a standard coupling: - Minimum diameter, 1/2 inches (13 mm). - Minimum length, 7.5 m.

- Screw the coupling unit (supplied) to the water connection on the appliance.
- Push the water supply hose onto the coupling unit, then connect it to the tap.

### ⚠ **Caution**

*Never operate the high-pressure cleaner when the tap is turned off as dry running will damage the HP pump.*

*If the water supply is not clean, the Kärcher water filter must be used (special accessory - order No. 4.730-059).*

### **Drawing in water from open reservoirs**

When fitted with the appropriate accessories, this high-pressure cleaner can draw in surface water, e.g. from water butts or ponds (max. suction height 0.5 m).

- Use the Kärcher water filter to protect the HP pump and accessories (special accessories, order no. 4.730-059). This filter removes dirt from incoming water.
- As the standard coupling system is not suitable for use in suction mode, the Kärcher suction hose with integrated filter should be used instead (special accessory, order no. 4.440-238) and suspended inside the water butt.

- Remove air from appliance before operation: Switch on the appliance when the HP hose is not connected and run it until the water which discharges from the HP outlet is free of bubbles. Switch off appliance and connect HP hose.

**Note:** If filling the suction hose with water before, the air better removes from the appliance.

## Start up

- Screw HP hose on to HP outlet on appliance.
- Push the appropriate spray lance on to the handgun and fasten it by turning it to the right through 90°.
- Open tap.
- Plug in mains plug.

- Set main switch to "I/ON".
- Press safety catch on the handgun to release it and pull lever.

### High pressure operation

#### **⚠ Risk of injury**

*The handgun is subjected to a recoil force when the water jet is discharged. Make sure that you have a firm footing and are also holding the handgun and spray lance firmly.*

#### **Spray lance with Variopower nozzle**

- Carrying out the most common cleaning tasks.

*Operation with detergents is possible with low pressure (-)*

#### **Spray lance with dirt blaster**

- for particularly stubborn stains.

*Operation with detergents not possible*

### Operation with detergent

#### **Note:**

*Detergent can only be added when the appliance is being operated in low pressure mode. All washing brushes supplied by Kärcher are designed for use with detergents.*

- Turn Variopower nozzle until lowest pressure setting has been reached (-).

#### **DT take-up from container**

- Pull the required length of the DT suction hose from the housing.
- Place the end the DT suction hose in a container with DT solution.

#### **Recommended Cleaning Method**

- 1 Spray a small dose of the detergent on the dry surface, and allow it to react (make sure the detergent does not dry up).
- 2 Wash off the loosened dirt using the high-pressure jet.

### Interrupting operation

- Release the lever on the handgun.
- During breaks, use the safety catch to secure the handgun lever.
- During longer breaks (more than 5 minutes), also turn the appliance off using the ON/OFF switch.

### Finish operation

- If detergent has been added: Suspend detergent suction hose in a container filled with clear water, switch the appliance on for around 1 minute once the spray lance has been removed and rinse until water runs clear.
- Release the lever on the handgun.
- Switch the appliance switch to "0/OFF".
- Turn off tap.
- Press the lever on the handgun to release any remaining pressure in the system.
- Disconnect the appliance from the water supply.
- Detach spray lance from the handgun.
- Briefly switch the appliance on ("I/ON"), press the handgun lever until no further water is discharged (approx. 1 min).
- Switch the appliance switch to "0/OFF".
- Use the safety catch to secure the handgun lever.
- Pull out the mains plug.
- Store the power cord, the HP hose and the accessories on the appliance.

### Special accessories

Special accessories expand the possibilities of using your appliance. Please contact your Kärcher dealer for further information.

### Detergents

To ensure a trouble-free operation of the appliance and to match the individual cleaning task, we recommend our Kärcher detergent and maintenance agents. Please ask for our advice, or request information on the products.

### Maintenance and Care

#### **⚠ Risk of injury**

*Always switch off the appliance and pull out the mains plug before care and maintenance work.*

## Cleaning

Prior to longer periods of storage, e.g. in the winter:

- ➔ Remove filter from suction hose for detergent and clean with running water.
- ➔ Pull out filter in water connection using flat-nose pliers and clean with running water.

## Maintenance

The appliance is maintenance-free.

## Frost protection

*Frost can destroy the not completely drained appliance. Store the appliance in a frost resistant room during winter.*

## Spare Parts

Only use original Kärcher spare parts. You will find a list of spare parts at the end of this document.

## Faults

You can rectify minor faults yourself with the help of the following overview.

If in doubt, please consult the authorized customer service.

### **Risk of injury**

*Always switch off the appliance and pull out the mains plug before care and maintenance work.*

### **Warning**

*Repair works may only be performed by the authorized customer service.*

### **Machine does not start**

- ➔ Check whether the voltage indicated on the type plate corresponds to the voltage of the socket.
- ➔ Check the power cable for damage.

### **Pressure does not build up in the appliance**

- ➔ Check the setting at the spray lance.
- ➔ Evacuate air from the appliance: Switch on the appliance when the HP hose is not connected and allow it to run until the water which discharges from the HP out-

let is free of bubbles. Then connect the HP hose again.

- ➔ Clean the filter in the water supply connection: This can be easily removed using flat-nose pliers.
- ➔ Check all supply lines to the HP pump for leaks or blockages.

### **Strong pressure fluctuations**

- ➔ Clean the high-pressure nozzle: Remove dirt and debris from the nozzle bore with a needle and rinse through with water towards the front.
- ➔ Check the volume of incoming water.

### **HP pump leaking**

- ➔ Slight leakage from the HP pump is normal. If the leakage increases contact the authorized customer service.

### **No detergent infeed**

- ➔ Select the low-pressure setting for the spray lance.
- ➔ Clean the filter of the detergent suction hose.
- ➔ Check the DT suction hose for kinks.

## CE declaration

We hereby declare that the machine described below complies with the relevant basic safety and health requirements of the EU Directives, both in its basic design and construction as well as in the version put into circulation by us. This declaration shall cease to be valid if the machine is modified without our prior approval.

PRODUCT: High-pressure cleaner

TYPE: 1.636-xxx

Relevant EU Directives:

98/37/EC

73/23/EEC (+93/68/EEC)

89/336/EEC (+91/263/EEC, 92/31/EEC, 93/68/EEC)

2000/14/EC

Applied harmonized standards:

DIN EN 60 335 – 1:

DIN EN 60 335 – 2 – 79

DIN EN 55 014-1:2000 + A1:2001 + A2:2002

DIN EN 55 014 – 2: 1997 + A1:2001

DIN EN 61 000 – 3 – 2: 2000  
 DIN EN 61 000 – 3 – 3: 1995 + A1: 2001  
 Applied conformity evaluation method: Appendix V  
 Measured sound power level: 84 dB(A)  
 Guaranteed sound power level: 85 dB(A)  
 Appropriate internal measures have been taken to ensure that the series appliances always comply with the requirements of the currently valid EU Directives and the applied standards. The undersigned act on behalf and under the power of attorney of the company management.

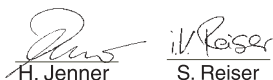

H. Jenner S. Reiser

Alfred Kärcher Kommanditgesellschaft. Location: Winnenden. Registration Court: Waiblingen, HRA 169 (Trade Register Section A 169). Partner liable to an unlimited extent: Kärcher Reinigungstechnik GmbH. Location: Winnenden, 2404 Registration Court Waiblingen, HRB (Trade Register Section B), Managing Director: Dr. Bernhard Graf, Hartmut Jenner, Georg Metz  
 Alfred Kärcher GmbH & Co. KG  
 Cleaning Systems  
 Alfred-Kärcher-Str. 28  
 P.O. Box 160  
 D - 71349 Winnenden  
 Phone: +49 7195 14-0  
 Fax: +49 7195 14-2212

## Help-Line

Kärcher (UK) Limited operate a help-line allowing customers to discuss any problems experienced with our products. The help-line operates during normal business hours, if you have difficulty getting through, please understand that there are peak periods during the day when our consultants are unable to take all calls coming in. In these circumstances we would ask that you try to contact us again later in the day. **The help-line number is 0906 6800632 from 8.30am to 5.00pm Monday - Friday. (calls to this number are charged at 25p per minute)**

It helps us if you have the model number and data plate details to hand before making your call as there are very many different models of Kärcher Pressure Washers in use.

**Alternatively you may write or e-mail to the address below:**

Kärcher (UK) Limited  
 Kärcher House  
 Beaumont Road  
 Banbury  
 Oxon, OX16 1TB

**E-mail:**  
 retail\_inquiries@karcheruk.co.uk

## Specifications

### Power connection

Voltage *UK (1~50 Hz)	240 V
*EUR (1~50 Hz)	230 V
Mains fuse *UK	13 A
* EUR	10 A
Connection output	1,7 kW
Protective class	I

### Water connection

Max. feed temperature	40 °C
Min. feed volume	10 l/min
Feed pressure,	0,2 - 1,2 MPa

### Performance data

Working pressure	11 MPa
Max. permissible pressure	12 MPa
Water flow rate	6,3 l/min
Detergent flow rate	0 - 0,3 l/min
Recoil force of handgun	15 N
Hand-arm vibration (ISO 5349)	0,8 m/s <sup>2</sup>
Sound pressure level Lpa (EN60704-1)	71 dB(A)
Sound power level Lwa (2000/14/EG)	85 dB(A)

### Dimensions

Length	336 mm
Width	334 mm
Height	837 mm
Weight	12,5 kg





**A**

Alfred Kärcher Ges.m.b.H.  
Lichtblaustraße 7  
1220 Wien  
☎ (01) 25 06 00

**AUS**

Kärcher Pty. Ltd.  
40 Koornang Road  
Scoresby VIC 3179  
Victoria  
☎ (03) 9765 - 2300

**B / LUX**

Kärcher N.V.  
Industrieweg 12  
2320 Hoogstraten  
☎ (03) 3400-711

**BR**

Kärcher Indústria e Comércio Ltda.  
Av. Prof. Benedito Montenegro 419  
CEP 13.140-000 - Paulínia - SP  
☎ 0800 17 61 11

**CH**

Kärcher AG  
Industriestraße 16  
8108 Dällikon  
☎ 0844 850 863

**CZ**

Kärcher spol.s.r.o.  
Za Mototechnou 1114/4  
155 00 Praha 5 - Stodůlky  
☎ (02)3552-1665

**D**

Alfred Kärcher GmbH & Co. KG  
Service-Center Gissigheim  
Im Gewerbegebiet 2  
97953 Königheim-Gissigheim  
☎ (07195) 903 20 65

**DK**

Kärcher Rengøringsystemer A/S  
Gejlhavegård 5  
6000 Kolding  
☎ 70 20 66 67

**E**

Kärcher, S.A.  
Pol. Industrial Font del Radium  
Calle Doctor Trueta, 6-7  
08400 Granollers (Barcelona)  
☎ (93) 846 44 47

**F**

Kärcher S.A.S.  
5, avenue des Coquelicots  
Z.A. des Petits Carreaux  
94865 Bonneuil-sur-Marne  
☎ (01) 43 99 67 70

**FIN**

Kärcher OY  
Yrittäjätie 17  
01800 Klaukkala  
☎ (09) 87919-191

**GR**

Kärcher Cleaning Systems A.E.  
31-33, Nikitara & Konstantinoupoleos str.  
136 71 Acharnes  
☎ (0210) 2316-153

**GB**

Kärcher(UK) Limited  
Kärcher House  
Beaumont Road,  
Banbury  
Oxon, OX16 1TB  
☎ 01295-752000; 0906-6800632

**H**

Kärcher Hungária Kft  
Tormásrét út 2.  
2051 Biatorbagy  
☎ (023) 530-640

**HK**

Kärcher Limited  
Unit 10, 17/F., APEC Plaza  
49 Hoi Yuen Road,  
Kwun Tong, Kowloon  
☎ (02) 357-5863

**I**

Kärcher S.p.A.  
Via A. Vespucci 19  
21013 Gallarate (VA)  
☎ 848 - 99 88 77

**IRL**

Kärcher Limited (Ireland)  
12 Willow Business Park  
Nangor Road  
Clondalkin  
Dublin 12  
☎ (01) 409 77 77

**KOR**

Kärcher Co. Ltd. (South Korea)  
5F, Wooree Venture Town Bldg.  
684-2, Deungchon3-dong  
Gangseo-Gu  
Seoul 157-033  
☎ (02) 3665-4181

**MAL**

Kärcher Cleaning Systems Sdn. Bhd.  
No. 8, Jalan Serindit 2  
Bandar Puchong Jaya  
47100 Puchong, Selangor  
☎ (03) 5882 1148

**MEX**

Kärcher México, SA de CV  
Av. Gustavo Baz Sur No. 29-C  
Col. Naucalpan Centro  
Naucalpan, Edo. de México  
C.P. 53000 México  
☎ 01-800-024-13-13

**N**

Kärcher AS  
Stanseveien 31  
0976 Oslo  
☎ (024) 1777-00

**NL**

Kärcher BV  
Postbus 474  
4870 AL Etten-Leur  
☎ (0499) 37 54 45

**NZ**

Kärcher Limited  
12 Ron Driver Place  
East Tamaki, Auckland  
☎ (09) 274-4603

**P**

Neoparts Com. e Ind. Automóvel, Lda.  
Largo Vitorino Damásio. 10  
1200 Lisboa  
☎ (21) 395 0040

**PL**

Kärcher Poland Ltd. Sp. z o.o.  
Ul. Stawowa 140  
31-346 Kraków  
☎ (012) 6397-222

**PRC**

Kaercher Cleaning Systems Co., Ltd.  
Part B, Building 30,  
No. 390 Ai Du Road  
Shanghai Waigaoqiao 200131  
☎ (021) 5046-3579

**RUS**

Kärcher Ltd.  
Vienna House  
Strastnoi Blv. 16  
107031 Moscow  
☎ 095-9338743

**S**

Kärcher AB  
Tagenvägen 31  
42502 Hisings-Kärå  
☎ (031) 577-300

**SGP**

Kärcher Asia Pacific Pte Ltd  
5 Toh Guan Road East  
#01-00 Freight Links Express Stripark  
Singapore 608831  
☎ 6897-1811

**TR**

Kärcher Servis Ticaret A.S.  
9 Eylül Mahallesi  
307 Sokak No. 6  
Gazimir / Izmir  
☎ (0232) 252-0708

**TWN**

Kärcher Taiwan Limited  
5F/6. No.7  
Wu-Chuan 1st Rd  
Wu-Ku Industrial Zone  
Taipei County  
☎ (02) 2299-9626

**UAE**

Kärcher FZE  
Jebel Ali Free Zone  
RA 8, XB 1, Jebel Ali, Dubai  
☎ (04) 8836-776

**ZA**

Kärcher (Pty) Limited  
144 Kuschke Street  
Meadowdale, Edenvale  
1614  
☎ (011) / 574-5360

07/05



www.kaercher.com