

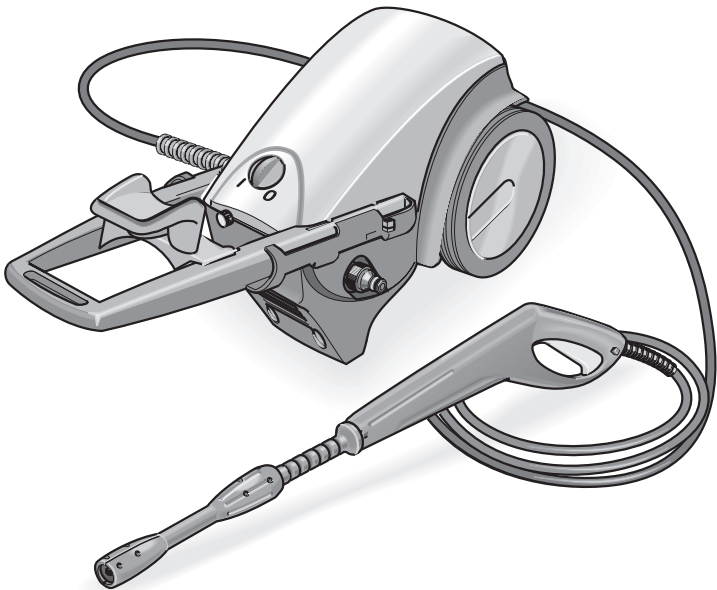

KÄRCHER

520 MH



THANK YOU FOR PURCHASING A **KARCHER** PRESSURE WASHER

PLEASE READ THIS LEAFLET CAREFULLY BEFORE OPERATING YOUR MACHINE.

WHAT IS A PRESSURE WASHER?

A Pressure Washer is essentially a powerful electric motor driving a set of pistons that force water through a small nozzle, thus creating a pressurised jet of water. This provides the cleaning power behind the **Karcher** Pressure Washer.

A **Karcher** Pressure Washer can be used for an endless list of applications around the home and garden. It provides an efficient, economical and labour saving way of cleaning with excellent results.

All **Karcher** domestic pressure washers are designed to run from a suitable cold water supply although some models will accept a water inlet temperature of between 40 °C and 60 °C.

Environmental Comment - Save water with high pressure.

*The **Karcher** Pressure Washer is environmentally friendly enabling you to reduce your water consumption compared to a normal garden hose. A definite advantage with a metered water supply*

OR

with the added benefit of suction mode, water can be drawn from an open container such as a water butt.

INDEX

- 1. APPLICATIONS**
- 2. SAFETY INSTRUCTIONS**
- 3. GETTING STARTED**
 - 3.1 Contents**
 - 3.2 Water Connection**
 - 3.3 Electrical Connection**
 - 3.4 Suction Mode**
 - 3.5 Detergent**
- 4. OPERATING YOUR PRESSURE WASHER**
 - 4.1 High Pressure Operation**
 - 4.2 Low Pressure Operation Without Brush**
 - 4.3 Low Pressure Operation With Brush**
 - 4.4 End Of Operation**
- 5. IMPORTANT – CARE AND MAINTENANCE**
- 6. ACCESSORIES / SPARE PARTS**
- 7. PROBLEM CHECKLIST / TROUBLESHOOTING**
- 8. HELP-LINE**
- 9. TECHNICAL DATA**
- 10. ASSEMBLY**

1. APPLICATIONS

*The main applications for this product are **DOMESTIC** cleaning tasks:*

- **Cars, motorbikes, caravans, boats and bicycles**
- **Patio's, fences, garden walls, pathways, driveways and house facades – particularly useful for cleaning block driveways**
- **Removal of algae and moss from roofs, brickwork and guttering**
- **Garden tools and machinery, furniture and barbecues**
- **Hygienic cleaning of animal pens and their surroundings**

*With the addition of **Karcher** accessories, the list continues*

- **Clearing blocked drains and pipes**
- **Removal of old paint and rust from garden furniture and gates**
- **Spraying insecticide onto trees, plants and lawns**

2. SAFETY INSTRUCTIONS

BEFORE STARTING UP YOUR PRESSURE WASHER PLEASE CHECK YOU HAVE THE FOLLOWING:

We recommend you purchase these items from a reputable store

- **RCD plug and socket that will interrupt electrical supply in an emergency.**
 - **A typical garden hose (minimum length 7.5 metres) with suitable hose connection (Hoselock/Gardena type) to match the coupling on the machine (hose and connector not supplied).**
-
- The mains voltage and supply indicated on the Rating Plate of the machine corresponds with that of the power source.
 - The insulation of the supply cable is not damaged.
 - Only earthed sockets should be used.
 - If you are using an extension cable it must be completely unwound from the cable drum and be the correct diameter:

**10 meter length of cable should have a cross section of 1.5 mm²
30 meter length of cable should have a cross section of 2.5 mm²**

Safety Assurance

As an added precaution, your pressure washer is fitted with a safety locking device on the Spray Gun.

**AFTER USE, ALWAYS REMOVE THE PLUG FROM THE SOCKET
BEFORE CLEANING YOUR PRESSURE WASHER**

3. GETTING STARTED

3.1 Contents

Upon opening the carton, if you do not have all the items as detailed please contact the Customer Helpline.

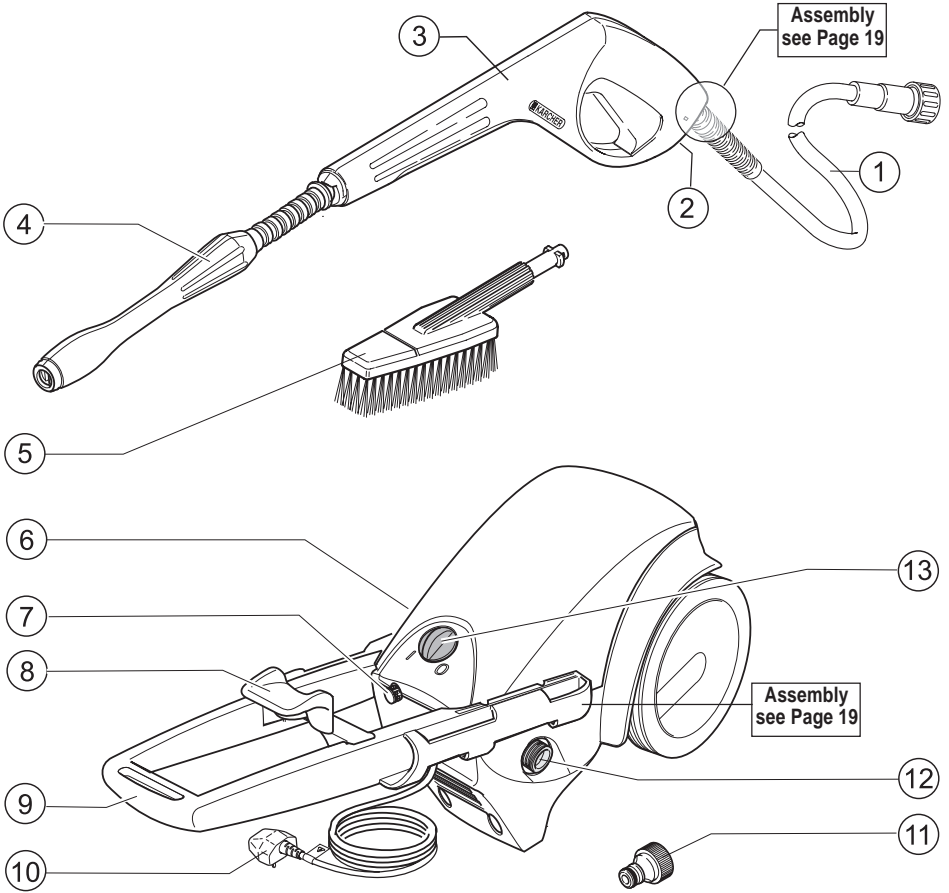

- | | |
|---------------------------------------|--|
| 1 High Pressure Hose | 8 Holder for High Pressure Hose |
| 2 Safety Lock Device | 9 Transport Bracket |
| 3 Spray Gun | 10 Mains Electric Lead with Plug |
| 4 Spray Lance with Pressure Regulator | 11 Hosepipe Connector |
| 5 Wash Brush | 12 Inlet Water Connection
(with Strainer) |
| 6 High Pressure Outlet | 13 On/Off Switch |
| 7 Detergent Suction Tube | |

***Please follow these instructions carefully
for troublefree cleaning.***

Use the diagram on Page 6 for reference purposes.

3.2 Water Connection

- The minimum length of supply hosepipe advised for maximum user convenience is 7.5 metres with a diameter of 12.5 mm (1/2") to allow free flow of inlet water to the machine so avoiding backpressure and any associated potential damage to your machine.
- Attach your supply hosepipe with its connector to the coupling on the machine (No.11) and the other end should be connected to a suitable water supply.

3.3 Electrical Connection

- Ensure the Power Switch (No.13) is in the "OFF" position before connecting the factory fitted Plug attached to the Mains Electric Lead (No.10) into an earthed socket. (it is recommended that an RCD plug socket is used.)

If using an Extension Cable make sure it is completely unwound from the cable drum and is the correct diameter.

3.4 Suction Mode - *an added benefit of the Karcher Pressure Washer*

- If you are drawing water from a static water supply such as a water butt disconnect the high pressure hose from the machine.
- Disconnect the water connection/hosepipe with coupling (No.11) from the machine and replace with a suction hose and filter (Part No. 4.440.238) that can be purchased as an accessory.
- Allow the pressure washer to operate without the high pressure hose fitted until water flows from the high pressure outlet **without bubbles**.
- Re-connect the high pressure hose to the high pressure outlet.

***Dirt in the drawn water could damage your Pressure Washer !
To avoid this risk please use a suitable filter - Part No. 6.414.389.***

3.5 Detergent

Only cleaning agents recommended by Karcher (UK) Ltd. should be used. Unsuitable detergents could damage your Pressure Washer and the object being cleaned.

Recommended Detergents

- 1. The following cleaning agent may be used undiluted:**
(But further dilution is practical but trial before application)
Universal Cleaner Profi RM 555 ASF

- 2. The following cleaning agents are available as concentrate and must be diluted with 9 parts of water (1 : 9) before use:**
Universal Cleaner Profi RM 555 ULTRA
Automotive Cleaner Profi RM 565 ULTRA
House & Garden Cleaner Profi RM 570 ULTRA
Boat Cleaner Profi RM 575 ULTRA

- 3. Detergent tablets are also available from some stores.**
Karcher Clean Tabs (10 tablets per box):
10 Tablets dissolved in clean water provide 5 litres of cleaning detergent.

DETAILS OF THE FULL RANGE OF DETERGENTS AND CHEMICALS ARE AVAILABLE BY CALLING THE KARCHER CUSTOMER HELPLINE ON 0906 6800632

4. OPERATING YOUR PRESSURE WASHER

If you have followed all the instructions so far, you are now ready to have fun cleaning the KARCHER way!!!

- Turn on the supply water and press the Spray Gun lever (No.3) until the water flows freely and removes all air locks from the hoses.
- You may now attach the bayonet fit Spray Lance (No.4) or required accessory to the Spray Gun.

All accessories are bayonet fit, simply push in and twist until they click into position !

- **Once water is flowing through the machine, you may now switch on your Karcher Pressure Washer using the Power Switch (No.13)**
- You can regulate the working pressure on the spray by turning the nozzle end of the Spray Lance (No.4) in a “+” or “-” direction.

WHEN USING YOUR KARCHER PRESSURE WASHER ON THE HIGH PRESSURE SETTING, THE RECOMMENDED WORKING DISTANCE BETWEEN THE NOZZLE AND THE OBJECT OR SURFACE TO BE CLEANED IS 30 CM. IT CAN BE CLOSER IF REQUIRED FOR PATIOS OR MASONERY.

When cleaning painted surfaces, ensure that the paint is sound and there are no signs of rusting or blistering.

It is your responsibility to check the suitability of the surface to be cleaned. **Karcher (UK) Ltd.** cannot be held responsible for any damage caused.

4.1 High Pressure Operation

- Switch on the pressure washer (No.13)
- Ensure the Spray Lance with the Pressure Regulator (No.4) is attached securely to the Spray Gun (No.3) and the nozzle is set to the required setting.
- Aim the lance towards the object to be cleaned making sure the recommended working distance is used (for reference see Page 9). Release the Safety Lock Device (No.2) on the Spray Gun and squeeze the lever.

The pressurised water jet alone is capable of fulfilling most cleaning tasks around the garden or on building work but detergent and wash brush are advantageous when cleaning vehicles or other paint finishes.

4.2 Low Pressure Operation without Brush

- Dilute the detergent in a suitable container to the required concentration before using. (The correct dilution is dependent on the degree of soiling of surface and is best determined by experience).
- Hang the Detergent Suction Tube (No.7) in the Detergent container.

Always ensure the Spray Gun is closed before changing the nozzle setting

- Set the nozzle to the lowest working pressure setting (-).
- Switch on the pressure washer (No.13)
- Aim the nozzle towards the object to be cleaned, release the Safety Locking Device on the Spray Gun and squeeze the lever to apply the detergent to the working area.
- To rinse the detergent away, close the Spray Gun, increase the nozzle setting towards “+” setting. **No detergent can be drawn in with a high working pressure.** Spray with the required jet spray setting until no trace of detergent can be found.

We recommend the following cleaning method:

Step 1:

Remove loose dirt by washing over the surface to be cleaned with the high pressure jet.

Step 2:

Spray on the detergent and leave for 1-4 minutes, so assisting the easy removal of fine dirt and associated greasy adhesions.

Step 3:

Finally, spray off the loosened dirt with the high pressure spray.

4.3 Low Pressure Operation with Brush

When cleaning surfaces with a grease contamination - typically car paintwork that always has a greasy traffic film covering adopt the following procedure:

- Washing loose dirt away with the clean water high pressure spray.
- Apply the detergent in low pressure mode by setting the bayonet fit spray lance (No.4) to its lowest (-) setting.
- Leave for 2-4 minutes for the detergent to have maximum effect.
- **Remove the bayonet fit spray lance and fit the Wash Brush (No.5) to the Spray Gun (No.3).** The Wash Brush is suitable for use with a water inlet temperature into the Pressure Washer of maximum 40 °C.
- With or without the pressure washer switched on, brush down the surface being cleaned, this physical agitation removes all trace of traffic film.
- Finally revert to the high pressure operation with the Spray Lance and complete the wash down.

4.4 End Of Operation

ALWAYS REMEMBER TO RINSE YOUR PRESSURE WASHER AFTER USING DETERGENT BY HANGING THE DETERGENT SUCTION TUBE IN A CONTAINER WITH CLEAN WATER AND RUN THE PUMP FOR APPROXIMATELY ONE MINUTE IN LOW PRESSURE SETTING.

In the event of a break of 5 minutes in the operation of your Karcher Pressure Washer, always switch off the pump to avoid damage due to overheating.

- Switch off the pressure washer by the Power Switch (No.13) and unplug the Mains Electric Lead (No.10) from the socket.
- Close the water inlet (tap) and disconnect the hosepipe.
- **Squeeze the lever to remove all pressure from the machine. Release the lever and then secure the lever with the Safety Locking Device to prevent accidental opening.**

5. IMPORTANT – CARE AND MAINTENANCE

To ensure prolonged life and trouble-free use of your Karcher Pressure Washer we strongly recommend that you always adopt the following procedures:

Water

- Before use, always check the inlet filter for dirt or debris.
- Visually check to see if the nozzle is blocked by dirt or grit, if so, remove the dirt from the nozzle hole with a needle and rinse with water from the front.

Failure to do this will seriously damage your machine and invalidate the warranty.

- Connect the water supply hose and, without the lance attached, squeeze the Spray Gun lever to run water through your pressure washer until the water flow is constant. Then plug in to the electric supply.
- Unless drawing water from an open water source such as a water butt, always have a minimum of 10 metres (25 feet) of uncoiled hose between the water tap and your machine. The internal diameter of the feed water hose should be 12 mm (1/2”).
- Water Regulations require the use of a back-flow preventer valve at the tap end of the supply hose.
Only use a full flow connector to connect the hose to the machine.

Electricity

- If using an electrical extension lead it must be rated at a minimum of 13 amps.
- Always fully uncoil any extension lead when used.

Chemicals

Use of chemicals other than those recommended by Karcher could cause significant damage which may not be covered by your warranty.

- After using chemicals, always run fresh water through your machine.
- The high pressure hose of your Karcher Pressure Washer should not be mistreated. It is designed to withstand high pressure operation so vehicles should NOT run over it, nor should it be pulled across sharp or abrasive edges. These actions may weaken the hose and cause ballooning.

IMPORTANT

REMEMBER FROST WILL DAMAGE YOUR KARCHER PRESSURE WASHER IF IT HAS NOT BEEN COMPLETELY EMPTIED OF WATER AFTER USE. ALWAYS STORE IN A FROST FREE AREA.

6. ACCESSORIES

A wide range of popular accessories are available from your local store selling Karcher Pressure Washers.

4.763-228 Dirt Blaster/Rotary Jet

A rapidly rotating pencil jet used to remove loose paint, stubborn algae and moss from hard surfaces.

4.760-269 Triple Nozzle Lance

An integral fan jet, pencil jet and low pressure chemical jet in one unit allows optimal nozzle selection.

4.760-212 Underbody Lance

Extended lance with angled end and upward firing jet for cleaning under cars, gutters etc.

6.903-276 Car Wash Brush

Simple bayonet fitting attaches the brush to the hand gun, used in conjunction with RM555.

4.762-065 Rotary Wash Brush

Ideal for car bodywork and windows as the water forces the brush to rotate enhancing cleaning power.

4.760-262 Extension Lance

To add length to the standard lance.

2.637-729 Drain Kit (7.5 m Hose)

2.637-767 Drain Kit (15 m Hose)

A flexible hose with backwards firing high pressure jet to create turbulence and dislodge blockages.

2.637-728 Sandblaster

Used to remove paint, rust and cement from metallic and stone surfaces by using a combination of high pressure water and sand.

4.760-265 Flexi Lance

A lance which can be angled to any degree to clean hard to reach areas such as wheel arches etc.

2.637-755 Floor Cleaning Lance

An extended lance fitted with three shrouded high pressure nozzles to provide a wide area of cleaning power without any splash back.

4.440-238 Suction Hose and Filter

Used to provide a water supply to the unit where a mains water supply is not available by placing the kit into a water butt.

6.541-040 Trolley

Eliminates the need to carry the pressure washer when the unit has no built in mobility.

6.964-006 Foam Nozzle

A bayonet fit accessory that generates a low pressure detergent foam. This allows longer detergent contact time on the surface to be cleaned.

2.637-214 Water Pump Kit

9.300-051 25 Kg Grit

6.291-080 RM 555 (5 litre)

6.291-079 RM 555 (6 x 1 litre)

6. Spare Parts

In the event that your Karcher Pressure Washer requires replacement parts – please refer to the diagram below AND identify the particular model of your machine by reference to the data plate on the underside.

Please write, email or fax Karcher (see page 17) with any parts order you wish to place. A premium rate **Help-line** Number is available for telephone enquires of any type.

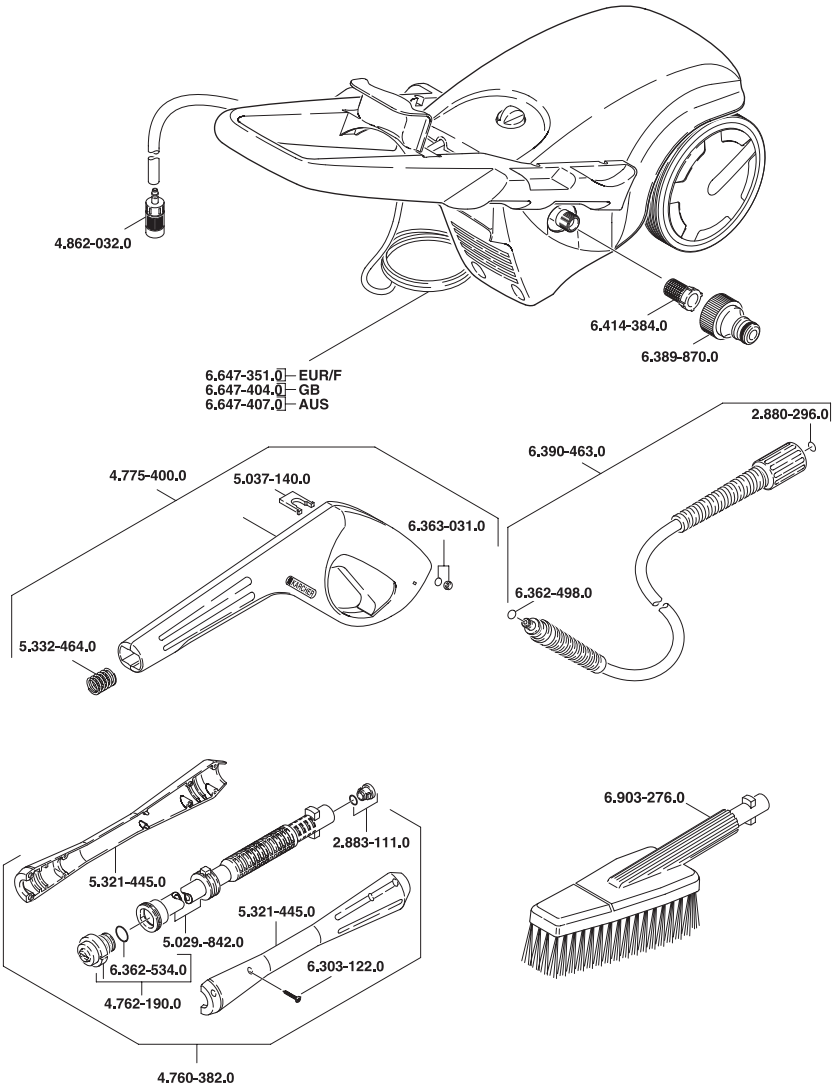

7. PROBLEM CHECKLIST

The machine you have chosen is of the highest quality. Correctly stored away from frost it should operate without problems. If a problem does arise, please check the following chart as a solution may be at hand.

PROBLEM	POSSIBLE CAUSE	CORRECTION
Machine refuses to start	Plug not connected	Connect plug
	Defective socket	Try another socket
	Fuse blown	Change the fuse
	Defective extension cable	Try without extension cable
	Wrong mains voltage	Check mains voltage corresponds to specifications of machine
Pump stops	Fuse blown	Change fuse and check size of extension cable
	Overheating due to poor water Supply	Check inlet water flow rate - hose should fill a 10 litre bucket in one minute
Strong pressure fluctuations	Nozzle partly blocked	Clean dirt from nozzle hole with needle and rinse from the front
	Inadequate mains water	Check inlet water flow rate
Machine does not reach operating pressure	Nozzle blocked/worn out	Clean/replace nozzle
	Inadequate mains water	Check inlet water flow rate
	Inlet hose squeezed	Straighten out hose
	Water filter clogged (3.1 item12)	Clean filter
	Inlet hose blocked	Check hose for leaks or blockages
No detergent suction	Wrong pressure	Set Spray Lance at the minimum working pressure
	Blocked filter in detergent tank	Unblock filter Clean ventilation hole in cover of Detergent Tank

In the unlikely event that you need to return your machine to your supplier, **please ensure that this is returned, complete with hose, gun and all accessories.**

8. HELP - LINE

Karcher (UK) Limited operate a help-line allowing customers to discuss any problems experienced with our products.

The help-line operates during normal business hours, if you have difficulty getting through, please understand that there are peak periods during the day when our consultants are unable to take all calls coming in. In these circumstances we would ask that you try to contact us again later in the day.

The help-line number is 0906 6800632.

It helps us if you have the model number and data plate details to hand before making your call as there are very many different models of Karcher Pressure Washers in use.

Alternatively you may write or e-mail to the address below:

**Karcher (UK) Limited
Karcher House
Beaumont Road
Banbury
Oxon, OX16 1TB
FAX: 01295 752030
E-mail: retail_inquiries@karcheruk.co.uk**

9. TECHNICAL DATA

Power Connection

Voltage	240	V (AC)
Current	1~50	Hz
Connected/Load	2.0	KW
Mains Fuse	13	AMP

Water Connection

Supply Temperature (Max)	60	°C
Supply Rate (Min)	600	Litres per Hour
Supply Pressure (Max)	12	bar
Supply Hose Length	7.5	metres
Diameter	1/2	inch
Suction Height from open tank at Water Temperature 20 °C	1	metre

Performance Data

Operating Pressure	20-120	bar
Flow Rate	450	litres per hour
Detergent Intake	0-25	litres per hour
Recoil Force of Spray Gun at Operating Pressure (Max)	21	N
Optimum Working Distance on High Pressure ..	30	cm
Noise L_{PA} (EN 60704-1)	74	dB(A)
L_{WA} (EN ISO 4871)	96	dB(A)

Dimensions

Length	728	mm
Width	312	mm
Height	388	mm
Weight	14	Kg

Circuit Diagramm

- C1 Running capacitor
- F1 Temperature fuse
- M1 Motor
- S1 Appliance switch
- S2 Pressure-operated switch

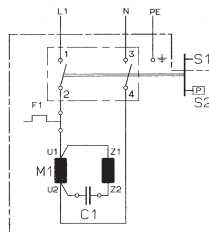

10. ASSEMBLY

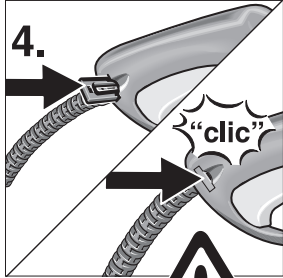
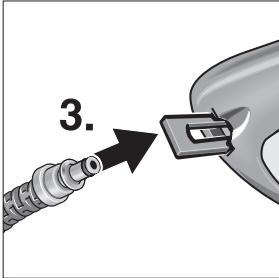
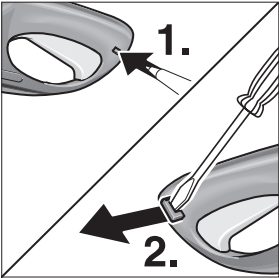
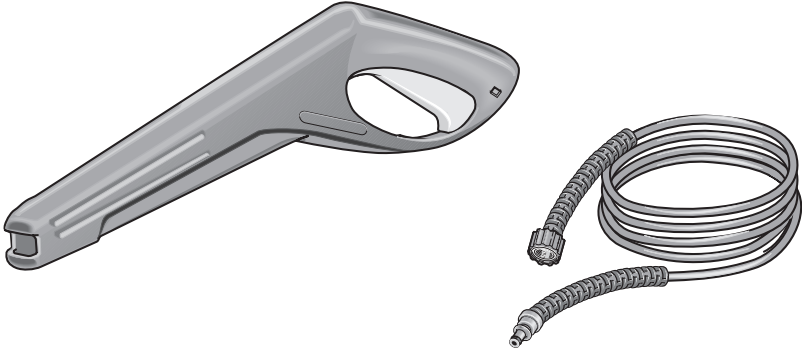
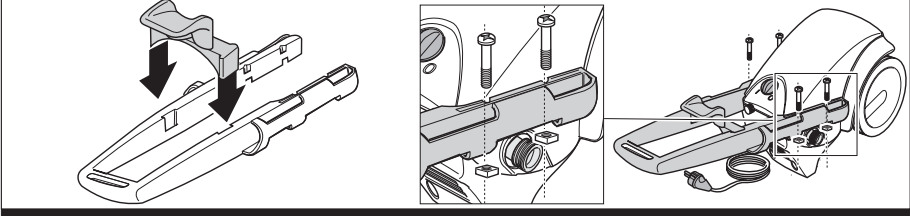

EU Declaration of Conformity

We hereby declare that the equipment described below conforms to the relevant fundamental safety and health requirements of the appropriate EU Directives, both in its basic design and construction as well as in the version marketed by us. This declaration will cease to be valid if any modifications are made to the machine without our express approval.

Product: **High Pressure Cleaner**

Model: **1.069-xxx**

Relevant EU Directives:

EU Low-Voltage Equipment Directive (93/68/EEC)

EU Machinery Directive (98/37/EEC)

EU Directive on Electromagnetic Compatibility (93/68/EEC)

Harmonised standards applied:

DIN EN 55014-1:1999

DIN EN 60335-1

DIN EN 61000-3-2:1995

DIN EN 55014-2:1997

DIN EN 60335-2-79

DIN EN 61000-3-3:2001

Appropriate internal measures have been taken to ensure that series-production units conform at all times to the requirements of current EU Directives and relevant standards. The signatories are empowered to represent and act on behalf of the company management.

Alfred Kärcher GmbH & Co.
Cleaning Systems
Alfred-Kärcher-Str. 28-40
P.O. Box 160
D-71349 Winnenden
Tel.: ++ 49 71 95 14-0
Fax: ++ 49 71 95 22 12

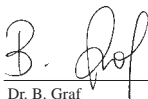
Dr. B. Graf

S. Reiser

H. Jenner

Alfred Kärcher Kommanditgesellschaft. Sitz Winnenden. Registergericht: Waiblingen, HRA 169.
Persönlich haftende Gesellschafterin: Kärcher Reinigungstechnik GmbH. Sitz Winnenden, 2404 Registergericht Waiblingen, HRB



KÄRCHER

<http://www.karcher.com>